

Part Number: APTB1612SURKCGKC-F01

Hyper Red  
Green

### Features

- 1.6mmx1.25mm SMT LED, 0.65mm THICKNESS.
- BI-COLOR,LOW POWER CONSUMPTION.
- WIDE VIEWING ANGLE.
- IDEAL FOR BACKLIGHT AND INDICATOR.
- VARIOUS COLORS AND LENS TYPES AVAILABLE.
- PACKAGE : 2000PCS / REEL.
- MOISTURE SENSITIVITY LEVEL : LEVEL 3.
- RoHS COMPLIANT.

### Description

The Hyper Red source color devices are made with DH InGaAlP on GaAs substrate Light Emitting Diode.  
The Green source color devices are made with InGaAlP on GaAs substrate Light Emitting Diode.

### Package Dimensions

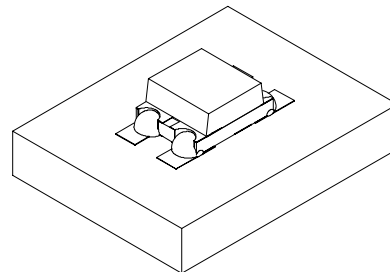
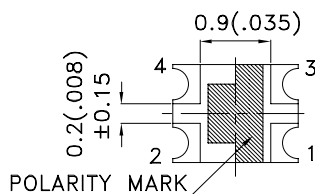
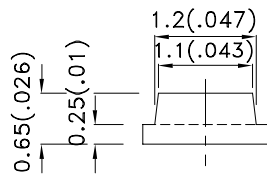
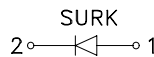
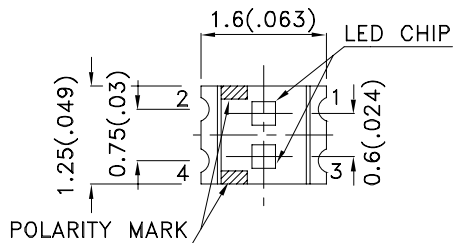

#### Notes:

1. All dimensions are in millimeters (inches).
2. Tolerance is  $\pm 0.2(0.008)$  unless otherwise noted.
3. Specifications are subject to change without notice.
4. The device has a single mounting surface. The device must be mounted according to the specifications.



## Selection Guide

Part No.	Dice	Lens Type	Iv (mcd) [2] @ 20mA		Viewing Angle [1]
			Min.	Typ.	2θ1/2
APT B1612SURKCGKC-F01	Hyper Red (InGaAlP)	WATER CLEAR	70	150	120°
	Green (InGaAlP)		18	50	

Notes:

1. θ1/2 is the angle from optical centerline where the luminous intensity is 1/2 the optical centerline value.
2. Luminous intensity/ Luminous Flux: +/-15%.

## Electrical / Optical Characteristics at TA=25°C

Symbol	Parameter	Device	Typ.	Max.	Units	Test Conditions
λ <sub>peak</sub>	Peak Wavelength	Hyper Red Green	650 574		nm	I <sub>F</sub> =20mA
λ <sub>D</sub> [1]	Dominant Wavelength	Hyper Red Green	635 570		nm	I <sub>F</sub> =20mA
Δλ <sub>1/2</sub>	Spectral Line Half-width	Hyper Red Green	28 20		nm	I <sub>F</sub> =20mA
C	Capacitance	Hyper Red Green	35 15		pF	V <sub>F</sub> =0V; f=1MHz
V <sub>F</sub> [2]	Forward Voltage	Hyper Red Green	1.95 2.1	2.5 2.5	V	I <sub>F</sub> =20mA
I <sub>R</sub>	Reverse Current	Hyper Red Green		10 10	μA	V <sub>R</sub> = 5V

Notes:

1. Wavelength: +/-1nm.
2. Forward Voltage: +/-0.1V.

## Absolute Maximum Ratings at TA=25°C

Parameter	Hyper Red	Green	Units
Power dissipation	75	75	mW
DC Forward Current	30	30	mA
Peak Forward Current [1]	185	150	mA
Reverse Voltage	5		V
Operating Temperature	-40°C To +85°C		
Storage Temperature	-40°C To +85°C		

Note:

1. 1/10 Duty Cycle, 0.1ms Pulse Width.

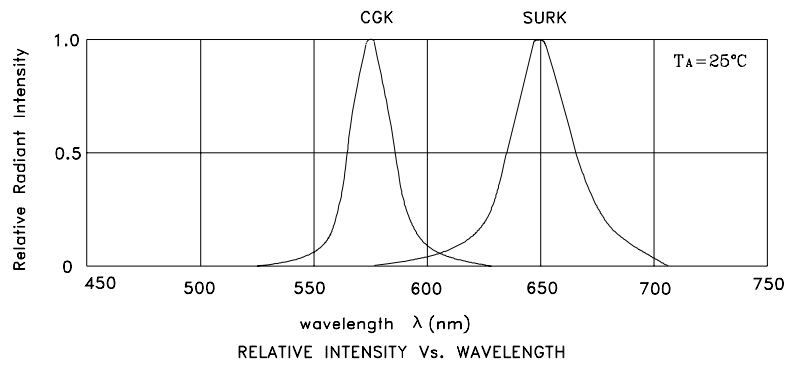

**APTB1612SURKCGKC-F01**  
**Hyper Red**

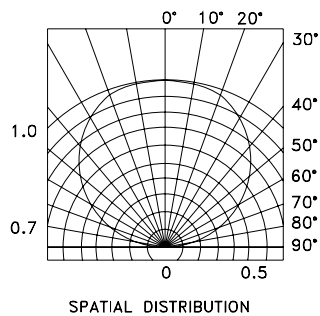
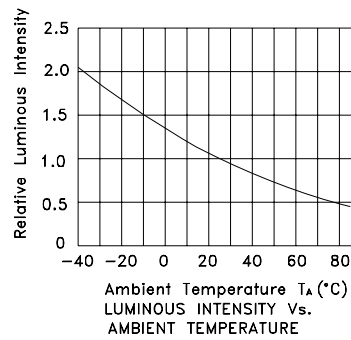
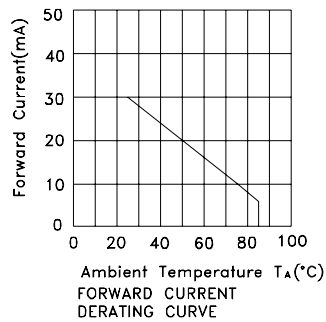
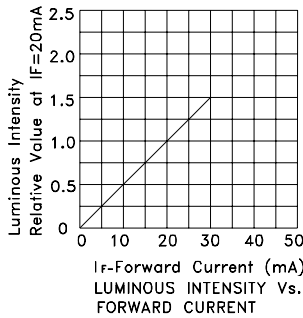
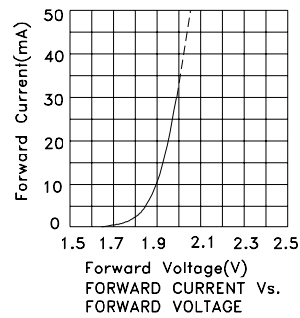

## Green

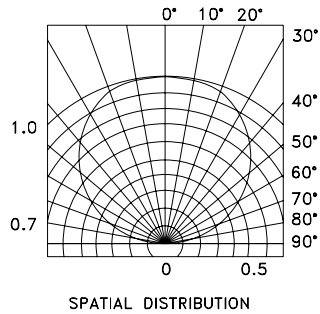
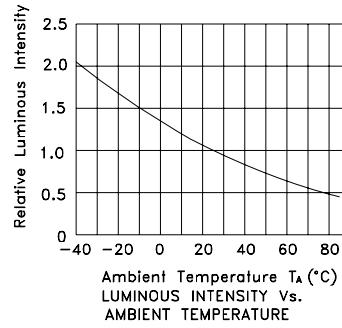
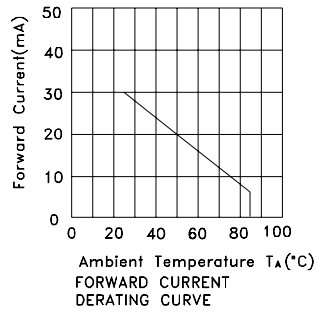
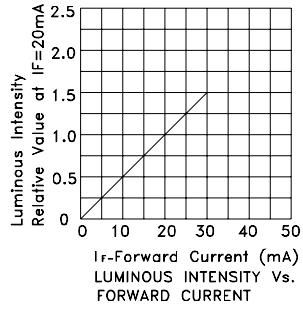
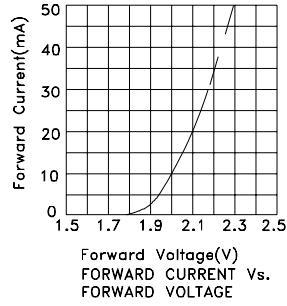

## APTB1612SURKCGKC-F01

Reflow Soldering Profile For Lead-free SMT Process.

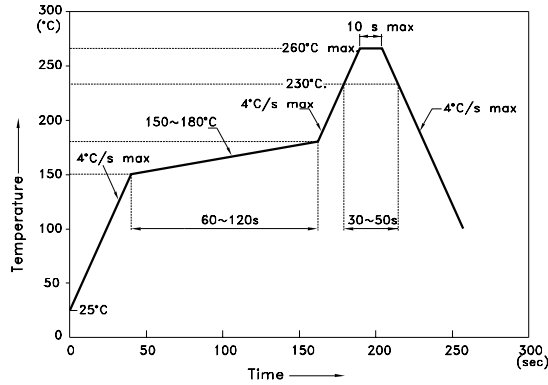

NOTES:

1. We recommend the reflow temperature 245°C(+/-5°C). The maximum soldering temperature should be limited to 260°C.
2. Don't cause stress to the epoxy resin while it is exposed to high temperature.
3. Number of reflow process shall be 2 times or less.

### Recommended Soldering Pattern (Units : mm; Tolerance: ± 0.1)

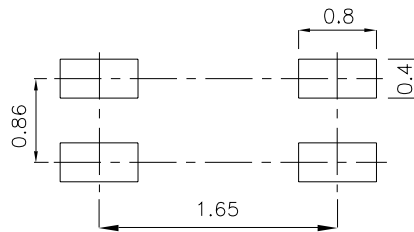

### Tape Specifications (Units : mm)

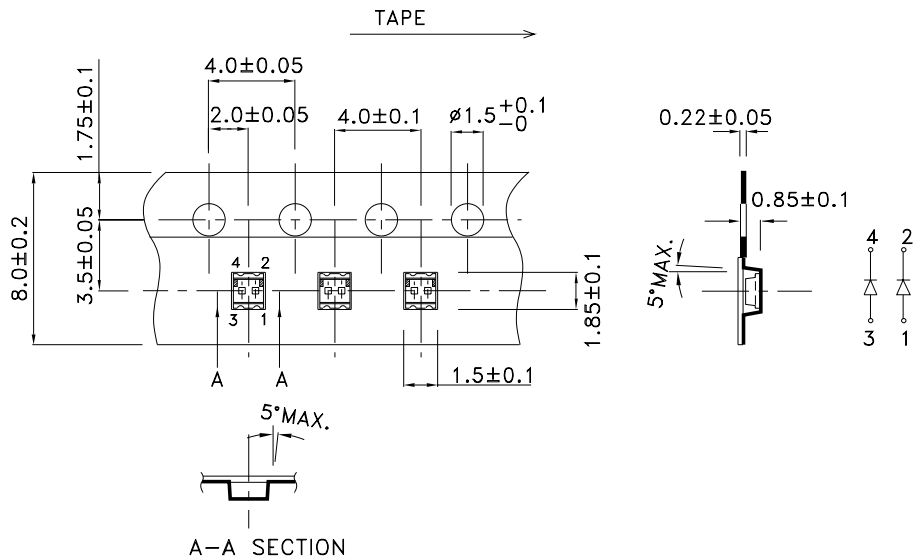

# Kingbright

## PACKING & LABEL SPECIFICATIONS

APTB1612SURKCGKC-F01

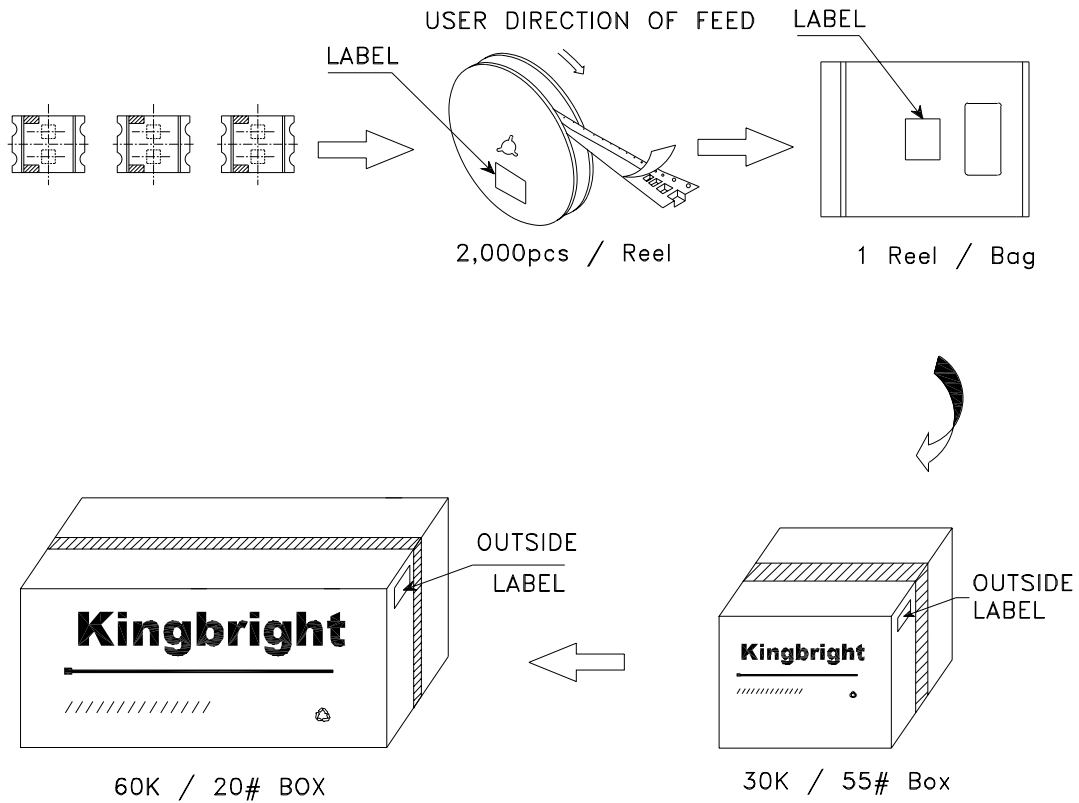

<h1>Kingbright</h1>	
P/NO: APTB1612xxx	
QTY: 2,000 pcs	Q.C. <span style="border: 1px solid black; border-radius: 50%; padding: 2px;">Q C xx xx xxxx PASSED</span>
S/N: XXXX	
CODE: XXX	
LOT NO:	
	
MADE IN CHINA	RoHS Compliant