

PRELIMINARY SPEC

Part Number: KPA-3010QWF-E

WHITE



ATTENTION
OBSERVE PRECAUTIONS
FOR HANDLING
ELECTROSTATIC
DISCHARGE
SENSITIVE
DEVICES

Features

- 3.0mmx1.0mm RIGHT ANGLE SMT LED, 2.0mm THICKNESS.
- LOW POWER CONSUMPTION.
- WIDE VIEWING ANGLE.
- IDEAL FOR BACK LIGHT AND INDICATOR.
- VARIOUS COLORS AND LENS TYPES AVAILABLE.
- PACKAGE : 2000PCS / REEL.
- MOISTURE SENSITIVITY LEVEL : LEVEL 3.
- RoHS COMPLIANT.

Description

The source color devices are made with AlInGaN on Sapphire Light Emitting Diode.
Static electricity and surge damage the LEDs.
It is recommended to use a wrist band or anti-electrostatic glove when handling the LEDs.
All devices, equipment and machinery must be electrically grounded.

Package Dimensions

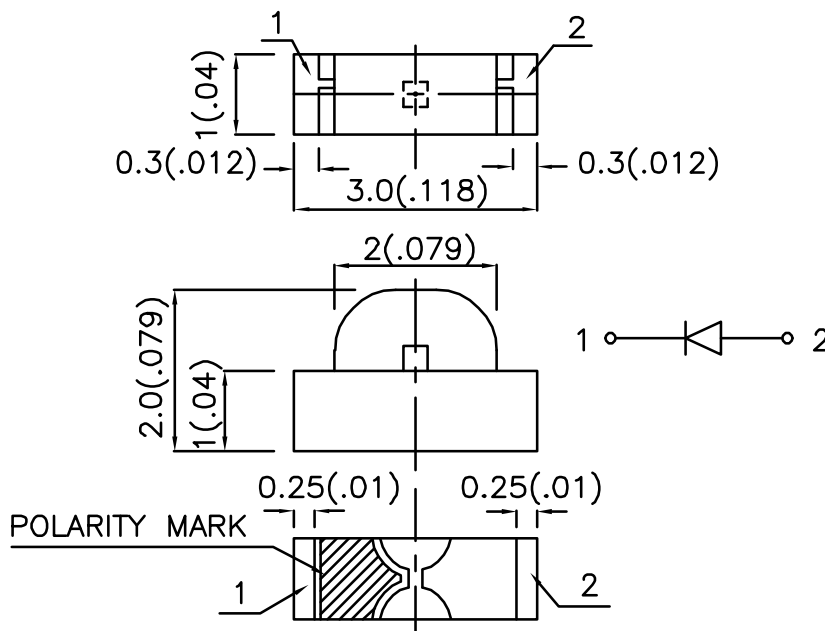

Notes:

1. All dimensions are in millimeters (inches).
2. Tolerance is $\pm 0.15(0.006)$ unless otherwise noted.
3. Specifications are subject to change without notice.

Selection Guide

Part No.	Dice	Lens Type	Iv (mcd) [2] @ 20mA		Viewing Angle [1]
			Min.	Typ.	2 θ 1/2
KPA-3010QWF-E	WHITE (AlInGaN)	YELLOW FLUORESCENT	110	360	120°

Notes:

1. θ1/2 is the angle from optical centerline where the luminous intensity is 1/2 the optical centerline value.
2. Luminous intensity / luminous flux: +/-15%.

Electrical / Optical Characteristics at TA=25°C

Symbol	Parameter	Device	Typ.	Max.	Units	Test Conditions
V _F [1]	Forward Voltage	White	3.3	4.0	V	I _F =20mA
I _R	Reverse Current	White		10	uA	V _R = 5V
X [2]	Chromaticity Coordinates	White	0.33			
Y [2]			0.34			
C	Capacitance	White	105		pF	V _F =0V;f=1MHz

Notes:

1. Forward Voltage: +/-0.1V.
2. Chromaticity Coordinates X, Y: +/-0.01.

Absolute Maximum Ratings at TA=25°C

Parameter	White	Units
Power dissipation	120	mW
DC Forward Current	30	mA
Peak Forward Current [1]	150	mA
Reverse Voltage	5	V
Operating/Storage Temperature	-40°C To +85°C	

Note:

1. 1/10 Duty Cycle, 0.1ms Pulse Width.

White

KPA-3010QWF-E

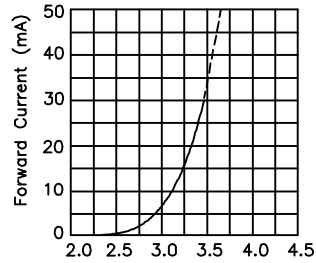

Forward Voltage(V)
FORWARD CURRENT Vs.
FORWARD VOLTAGE

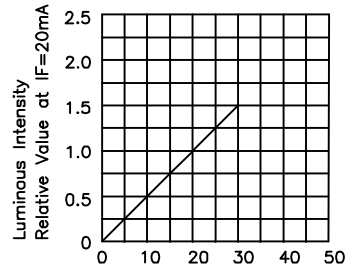

IF-Forward Current (mA)
LUMINOUS INTENSITY Vs.
FORWARD CURRENT

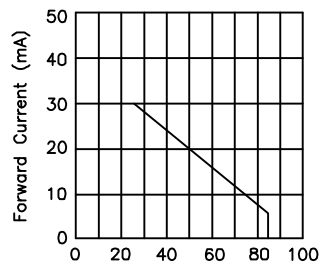

Ambient Temperature TA (°C)
FORWARD CURRENT
DERATING CURVE

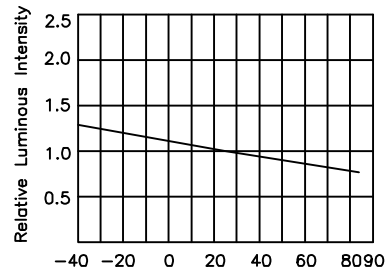

Ambient Temperature TA (°C)
LUMINOUS INTENSITY Vs.
AMBIENT TEMPERATURE

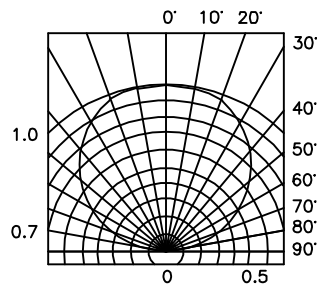

SPATIAL DISTRIBUTION

KPA-3010QWF-E

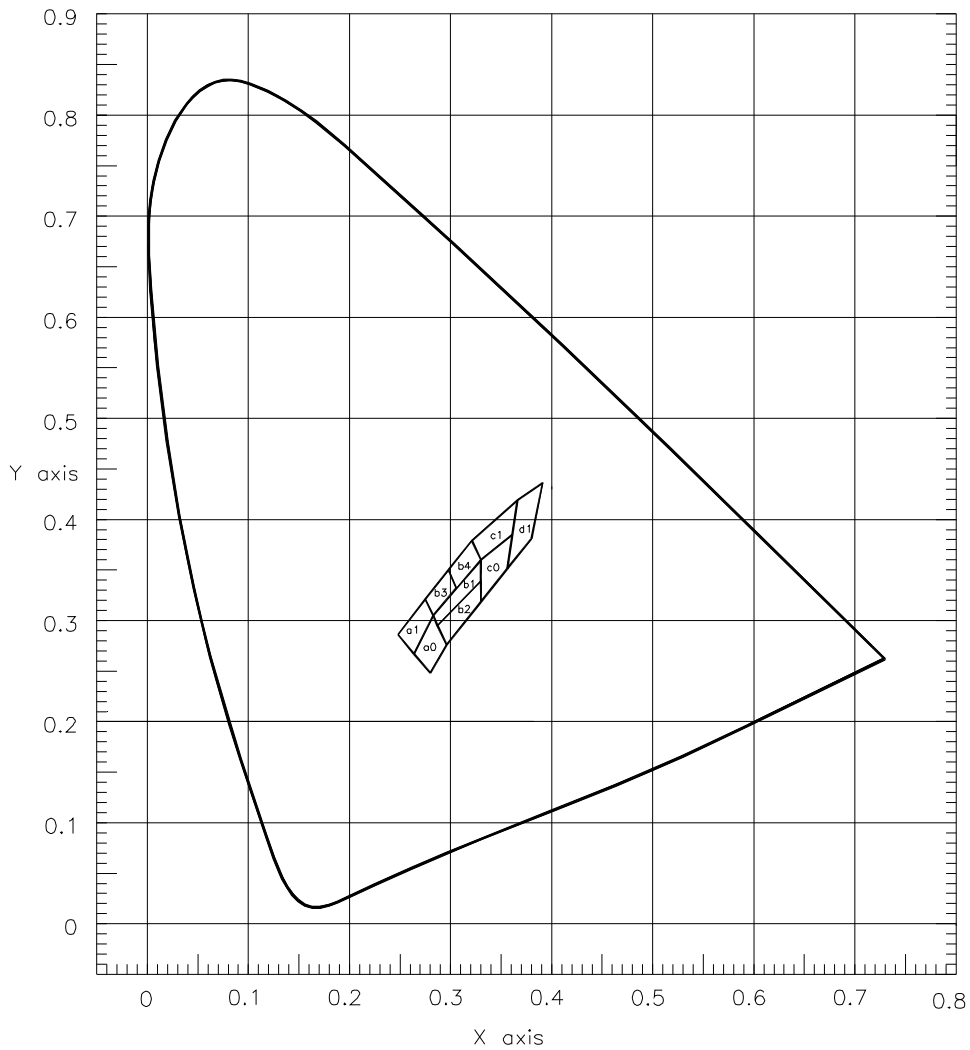

a1				
X	0.248	0.275	0.283	0.264
Y	0.286	0.321	0.305	0.267
b1				
X	0.283	0.330	0.330	0.287
Y	0.305	0.360	0.339	0.295
c1				
X	0.321	0.366	0.361	0.330
Y	0.379	0.419	0.385	0.360

a0				
X	0.264	0.283	0.296	0.280
Y	0.267	0.305	0.276	0.248
b2				
X	0.287	0.330	0.330	0.296
Y	0.295	0.339	0.318	0.276
c0				
X	0.330	0.361	0.356	0.330
Y	0.360	0.385	0.351	0.318

b3				
X	0.275	0.298	0.306	0.283
Y	0.321	0.350	0.332	0.305
b4				
X	0.298	0.321	0.330	0.306
Y	0.350	0.379	0.360	0.332
d1				
X	0.366	0.391	0.380	0.356
Y	0.419	0.436	0.381	0.351

Ta=25°, IF=20mA

Measurement Uncertainty of the Color Coordinates: +/-0.01

KPA-3010QWF-E

Reflow Soldering Profile For Lead-free SMT Process.

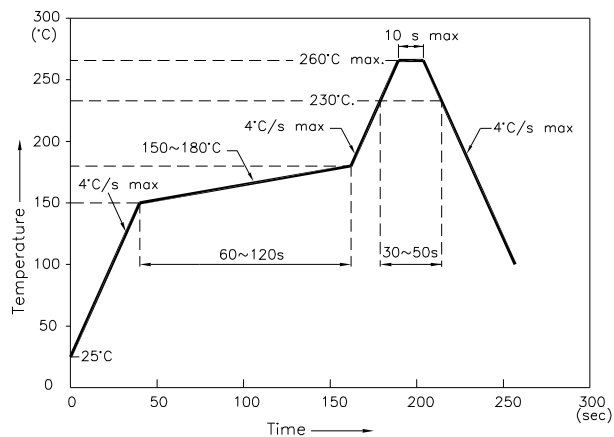

NOTES:

1. We recommend the reflow temperature 245°C(+/-5°C). The maximum soldering temperature should be limited to 260°C.
2. Don't cause stress to the epoxy resin while it is exposed to high temperature.
3. Number of reflow process shall be 2 times or less.

Recommended Soldering Pattern (Units : mm; Tolerance: ±0.1)

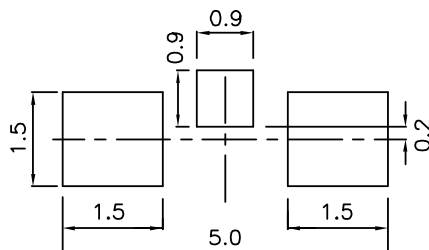

Tape Specifications (Units : mm)

