

Part Number: PSA12-11SURKWA Hyper Red

Features

- 1.2 inch character height .
- Low current operation.
- High contrast and light output.
- Easy mounting on P.C. boards or sockets.
- Categorized for luminous intensity.
- Mechanically rugged.
- Standard:gray face, white segment.
- RoHS compliant.

Description

The Hyper Red source color devices are made with Al-GaN on GaAs substrate Light Emitting Diode.

Package Dimensions& Internal Circuit Diagram

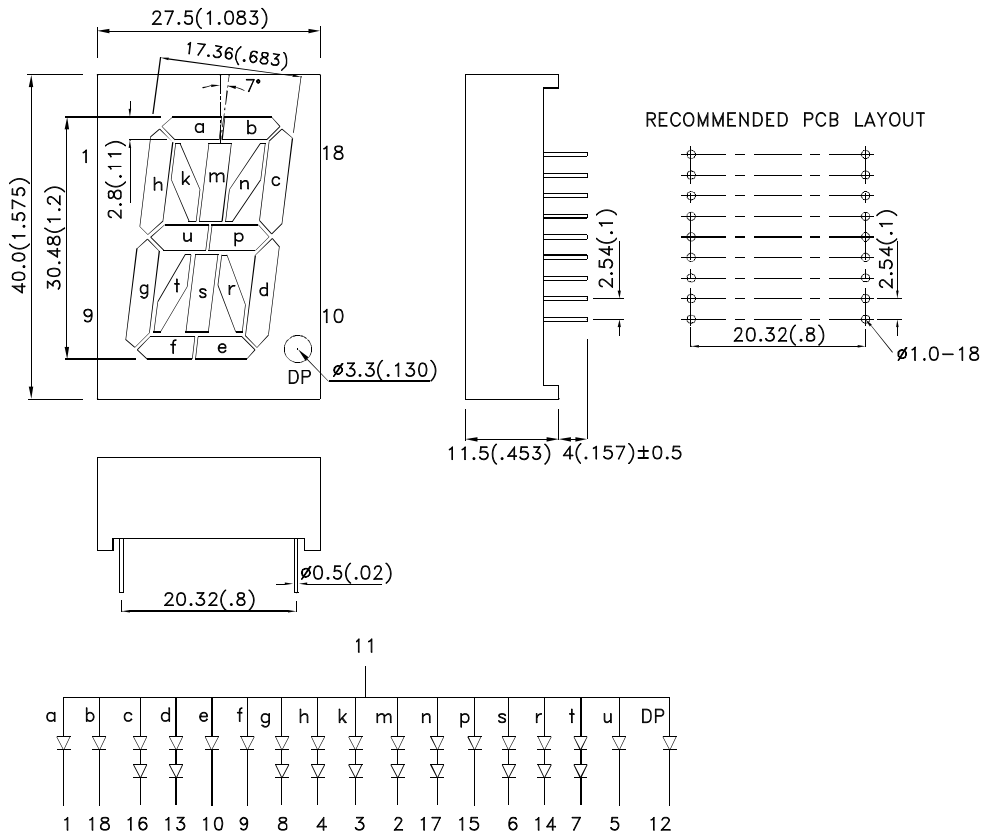

Notes:

1. All dimensions are in millimeters (inches), Tolerance is $\pm 0.25(0.01)$ unless otherwise noted.
2. The specifications, characteristics and technical data described in the datasheet are subject to change without prior notice.



Selection Guide

Part No.	Dice	Lens Type	Iv (ucd) [1] @ 10mA		Description
			Min.	Typ.	
PSA12-11SURKWA	Hyper Red (AlGaInP)	White Diffused	31000	63000	Common Cathode, Rt. Hand Decimal.

Note:

1. Luminous intensity/ luminous Flux: +/-15%.

Electrical / Optical Characteristics at TA=25°C

Symbol	Parameter	Device	Typ.	Max.	Units	Test Conditions
λ_{peak}	Peak Wavelength	Hyper Red	650		nm	IF=20mA
λ_D [1]	Dominant Wavelength	Hyper Red	630		nm	IF=20mA
$\Delta\lambda_{1/2}$	Spectral Line Half-width	Hyper Red	28		nm	IF=20mA
C	Capacitance	Hyper Red	35		pF	VF=0V;f=1MHz
VF [2]	Forward Voltage	c,d,g,h,k,m,n,s,r,t	3.9	5.0	V	IF=20mA
		a,b,e,f,p,u and DP	1.95	2.5		
IR	Reverse Current	c,d,g,h,k,m,n,s,r,t		10	uA	VR=5V
		a,b,e,f,p,u and DP		10		

Notes:

1. Wavelength: +/-1nm.

2. Forward Voltage: +/-0.1V.

Absolute Maximum Ratings at TA=25°C

Parameter	Super Bright Red	Units
Power dissipation	c,d,g,h,k,m,n,s,r,t	150
	a,b,e,f,p,u and DP	(75)
DC Forward Current	c,d,g,h,k,m,n,s,r,t	30
	a,b,e,f,p,u and DP	(30)
Peak Forward Current [1]	c,d,g,h,k,m,n,s,r,t	185
	a,b,e,f,p,u and DP	(185)
Reverse Voltage	c,d,g,h,k,m,n,s,r,t	5
	a,b,e,f,p,u and DP	
Operating/Storage Temperature	-40°C To +85°C	
Lead Solder Temperature [2]	260°C For 3-5 Seconds	

Notes:

1. 1/10 Duty Cycle, 0.1ms Pulse Width.

2. 2mm below package base.

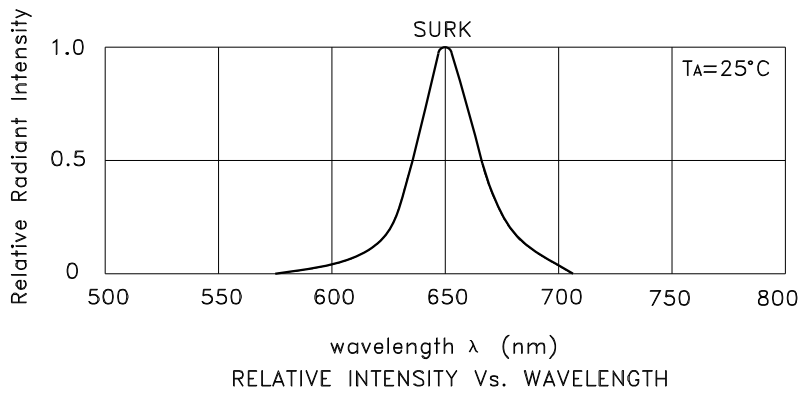

Hyper Red

PSA12-11SURKWA

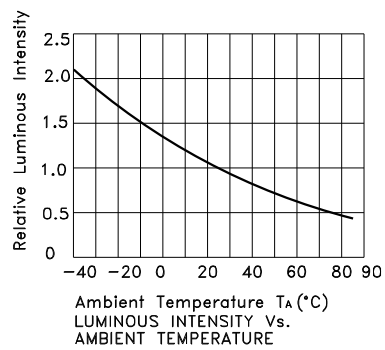
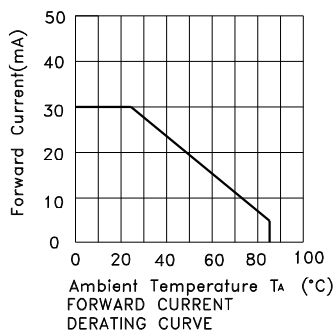
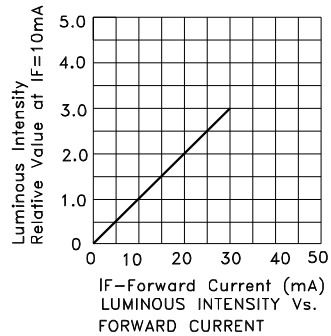
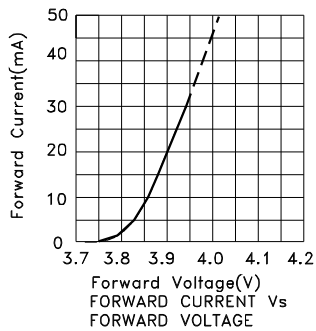

Note: the curves are on the segment c,d,g,h,k,m,n,s,r and t.

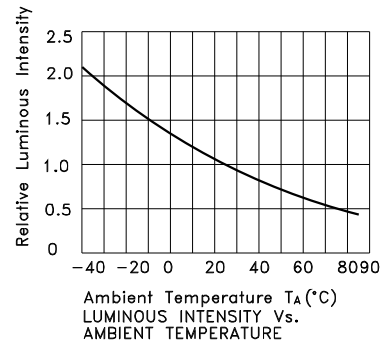
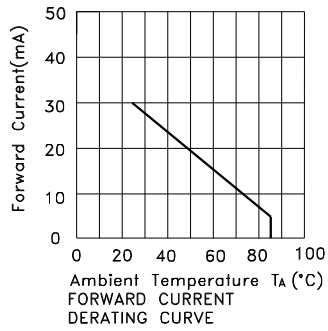
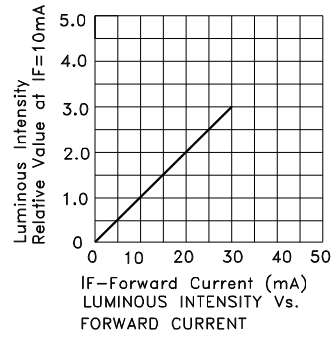
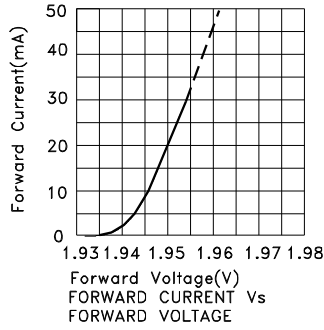

Note:the curves are on the segment a,b,e,f,p,u and DP.

PACKING & LABEL SPECIFICATIONS

PSA12-11SURKWA

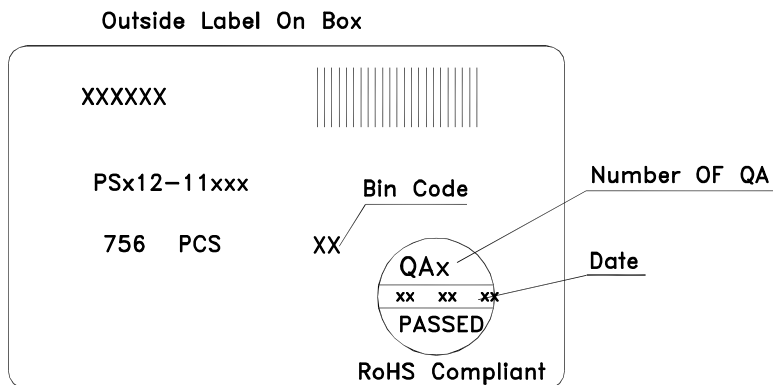
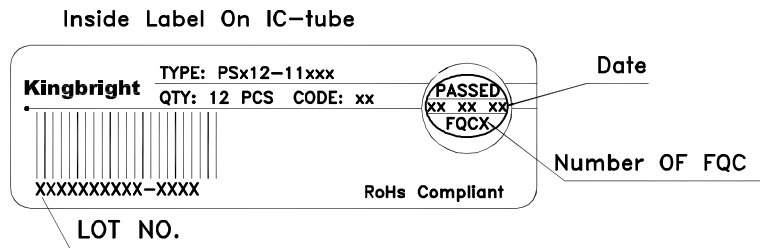
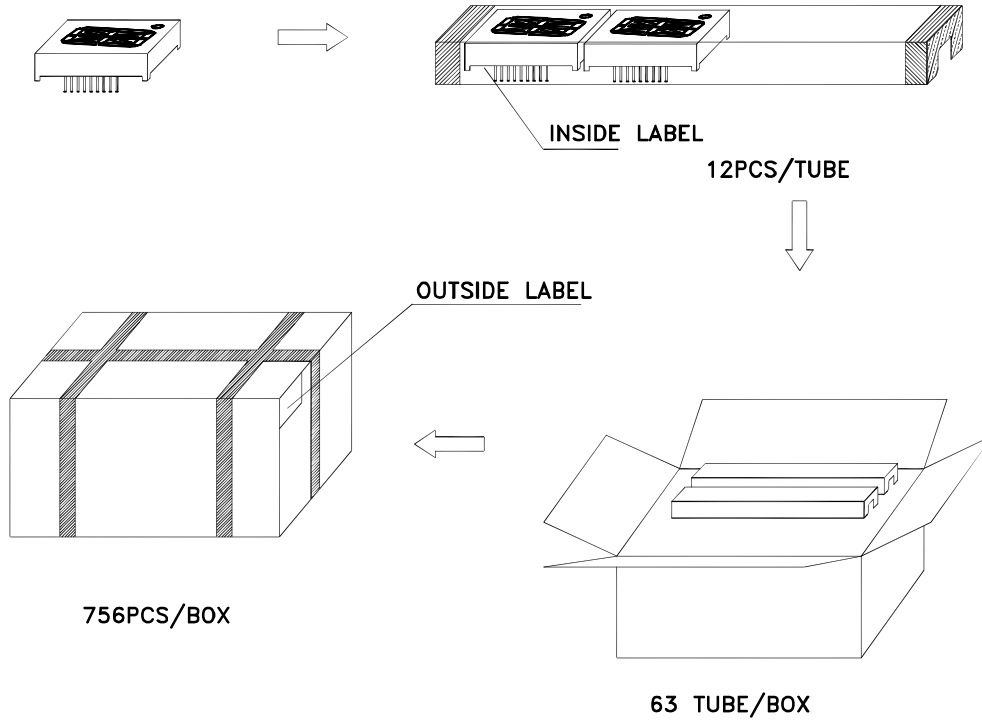

THROUGH HOLE DISPLAY MOUNTING METHOD

Lead Forming

Do not bend the component leads by hand without proper tools.
The leads should be bent by clinching the upper part of the lead firmly such that the bending force is not exerted on the plastic body.

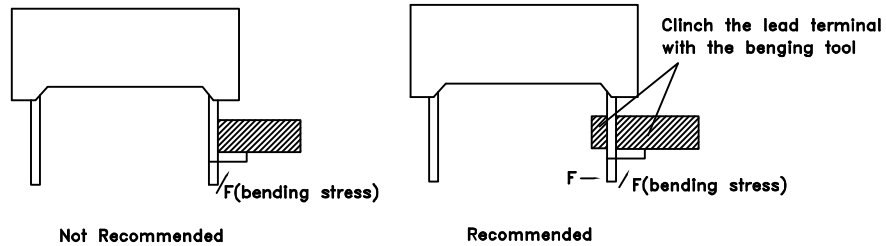

Installation

- 1.The installation process should not apply stress to the lead terminals.
- 2.When inserting for assembly, ensure the terminal pitch matches the substrate board's hole pitch to prevent spreading or pinching the lead terminals.

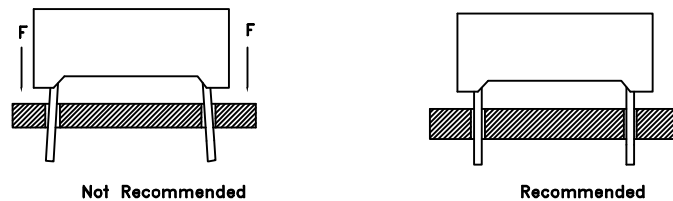

DISPLAY SOLDERING CONDITIONS

Wave Soldering Profile For Lead-free Through-hole LED.

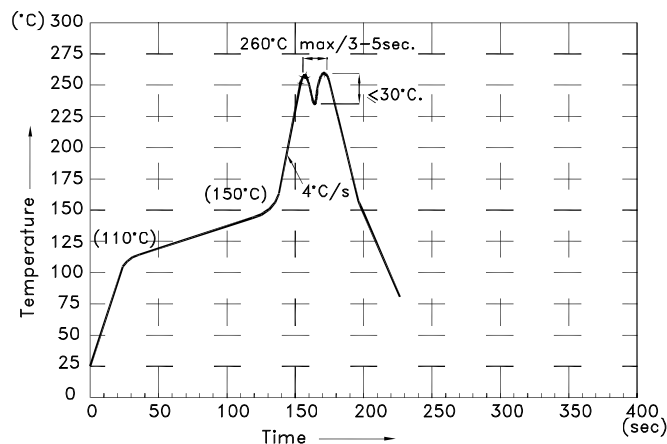

NOTES:

- 1.Recommend the wave temperature 245°C~260°C.The maximum soldering temperature should be less than 260°C.
- 2.Do not apply stress on epoxy resins when temperature is over 85°C.
- 3.The soldering profile apply to the lead free soldering (Sn/Cu/Ag alloy).
- 4.During wave soldering , the PCB top-surface temperature should be kept below 105°C
- 5.No more than once.

Soldering General Notes:

- a. Through-hole displays are incompatible with reflow soldering.
- b. If components will undergo multiple soldering processes, or other processes where the components may be subjected to intense heat, please check with Kingbright for compatibility.

CLEANING

1. Mild "no-clean" fluxes are recommended for use in soldering.
2. If cleaning is required, Kingbright recommends to wash components with water only. Do not use harsh organic solvents for cleaning, because they may damage the plastic parts. And the devices should not be washed for more than one minute.

CIRCUIT DESIGN NOTES

1. Protective current-limiting resistors may be necessary to operate the Displays.
2. LEDs mounted in parallel should each be placed in series with its own current-limiting resistor.

