

# LT1□82A series

## 3.3X2.9mm, 1.1mm Thickness, High-luminosity Chip LED Devices with Lens

### Outline Dimensions

(Unit : mm)

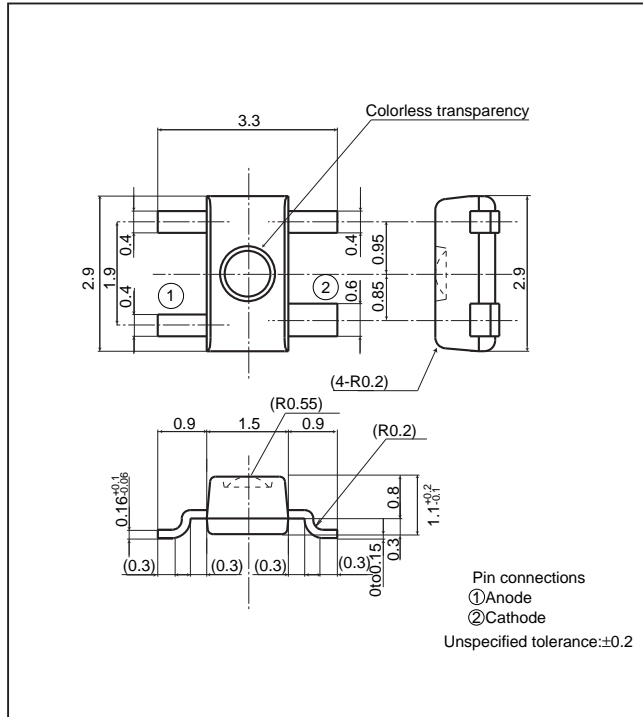

### Radiation Diagram

(T<sub>a</sub>=25°C)

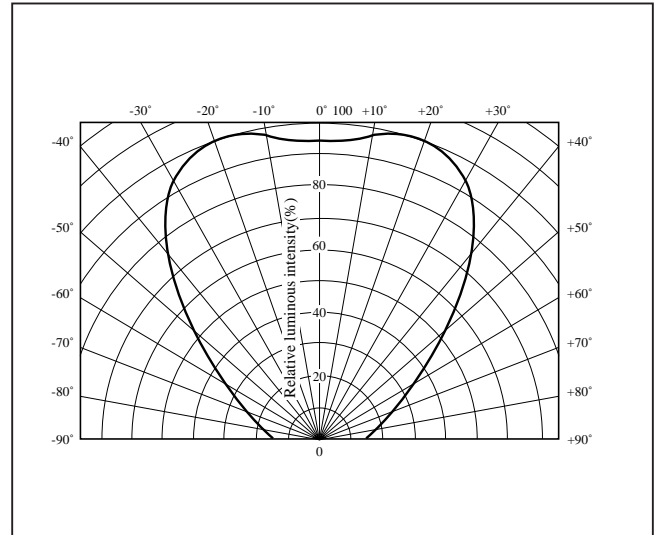

U,T type: Polarity faces in the opposite direction.

### Absolute Maximum Ratings

(T<sub>a</sub>=25°C)

Model No.	Radiation color	Radiation material	Power dissipation P (mW)	Forward current I <sub>F</sub> (mA)	Peak forward current I <sub>FM</sub> *1 (mA)	Derating factor (mA/°C)		Reverse voltage V <sub>R</sub> (V)	Operating temperature T <sub>opr</sub> (°C)	Storage temperature T <sub>stg</sub> (°C)	Soldering temperature T <sub>sol</sub> *2 (°C)
						DC	Pulse				
LT1U82A	Red(Super-luminosity)	GaAlAs on GaAlAs	75	30	50	0.40	0.67	4	-25 to +85	-25 to +100	350
LT1T82A	Red(High-luminosity)	GaAlAs on GaAs	66	30	50	0.40	0.67	5	-25 to +85	-25 to +100	350
LT1P82A	Red	GaP	23	10	50	0.13	0.67	5	-25 to +85	-25 to +100	350
LT1D82A	Red	GaAsP on GaP	85	30	50	0.40	0.67	5	-25 to +85	-25 to +100	350
LT1S82A	Sunset orange	GaAsP on GaP	85	30	50	0.40	0.67	5	-25 to +85	-25 to +100	350
LT1H82A	Yellow	GaAsP on GaP	50	20	50	0.27	0.67	5	-25 to +85	-25 to +100	350
LT1E82A	Yellow-green	GaP	50	20	50	0.27	0.67	5	-25 to +85	-25 to +100	350
LT1K82A	Green	GaP	50	20	50	0.27	0.67	5	-25 to +85	-25 to +100	350

\*1 Duty ratio=1/10, Pulse width=0.1ms

\*2 For 3s or less at the temperature of hand soldering. Temperature of reflow soldering is shown on the below page.

### Electro-optical Characteristics

(T<sub>a</sub>=25°C)

Lens type	Model No.	Forward voltage V <sub>F</sub> (V)		Peak emission wavelength λ <sub>p</sub> (nm)		Luminous intensity I <sub>v</sub> (mcd)		Spectrum radiation bandwidth Δλ(nm)		Reverse current I <sub>R</sub> (μA)		Terminal capacitance C <sub>t</sub> (pF)		Page for characteristics diagrams
		TYP	MAX	TYP	I <sub>F</sub> (mA)	TYP	I <sub>F</sub> (mA)	TYP	I <sub>F</sub> (mA)	MAX	V <sub>R</sub> (V)	TYP	(MHz)	
Colorless transparency	LT1U82A	1.85	2.5	660	20	54.0	20	20	20	100	3	25	1	→
	LT1T82A	1.75	2.2	660	20	13.1	20	20	20	10	4	30	1	→
	LT1P82A	1.9	2.3	695	5	1.6	5	100	5	10	4	55	1	→
	LT1D82A	2.0	2.8	635	20	14.4	20	35	20	10	4	20	1	→
	LT1S82A	2.0	2.8	610	20	11.7	20	35	20	10	4	15	1	→
	LT1H82A	1.9	2.5	585	10	5.6	10	30	10	10	4	35	1	→
	LT1E82A	1.95	2.5	565	10	7.8	10	30	10	10	4	35	1	→
LT1K82A	1.95	2.5	555	10	2.7	10	25	10	10	4	40	1	→	

(Notice) • In the absence of confirmation by device specification sheets, SHARP takes no responsibility for any defects that may occur in equipment using any SHARP devices shown in catalogs, data books, etc. Contact SHARP in order to obtain the latest device specification sheets before using any SHARP device.

(Internet) • Data for sharp's optoelectronic/power device is provided for internet.(Address <http://www.sharp.co.jp/ecg/>)

# LED Lamp Characteristics Diagrams

## UR series

Forward Current Derating Curve

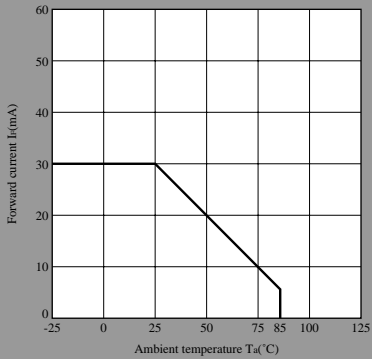

Forward Current vs. Forward Voltage(Note)

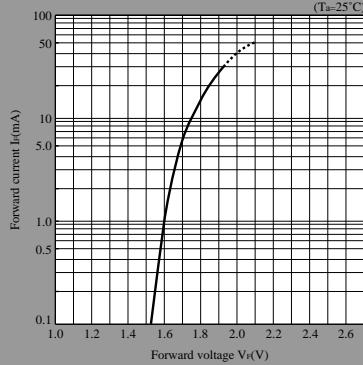

Luminous Intensity vs. Ambient Temperature(Note)

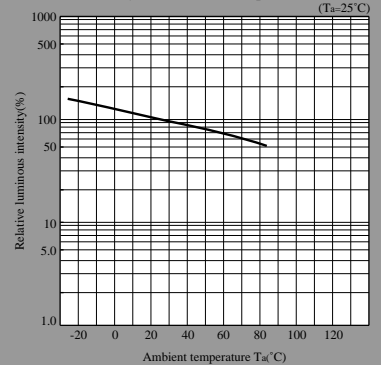

Peak Forward Current Derating Curve

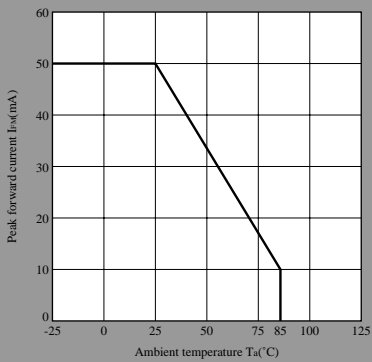

Luminous Intensity vs. Forward Current(Note)

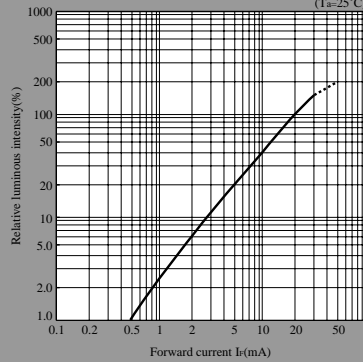

Duty Ratio vs. Peak Forward Current

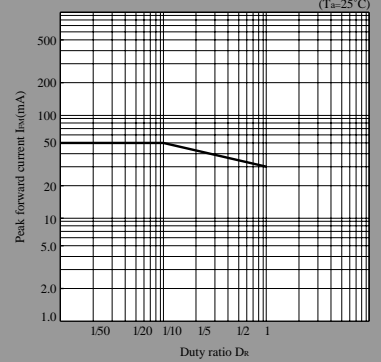

## TR series

Forward Current Derating Curve

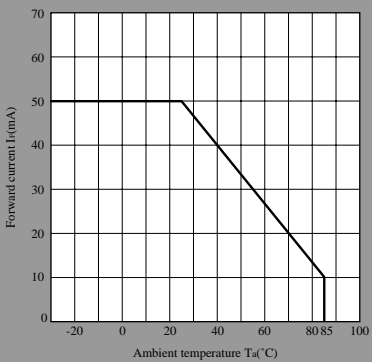

Forward Current vs. Forward Voltage(Note)

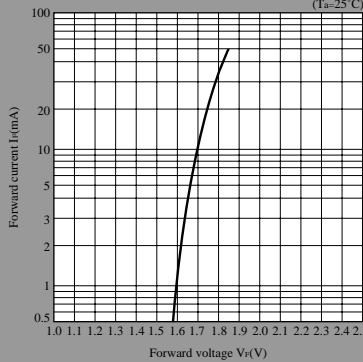

Luminous Intensity vs. Ambient Temperature(Note)

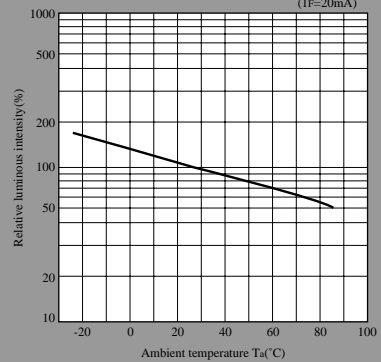

Peak Forward Current Derating Curve

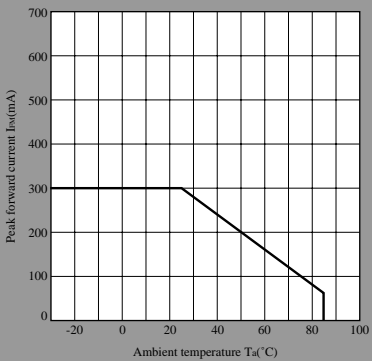

Luminous Intensity vs. Forward Current(Note)

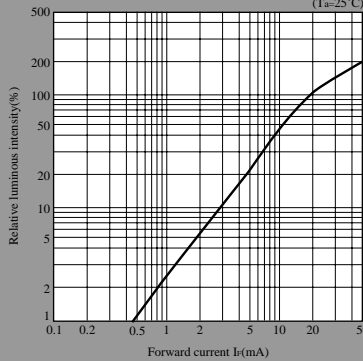

Duty Ratio vs. Peak Forward Current

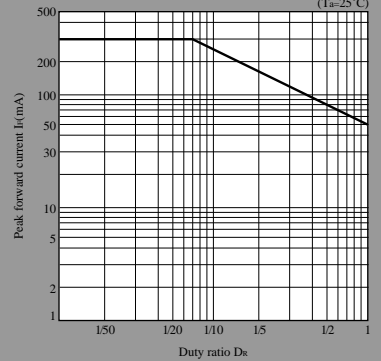

Note) Characteristics shown in diagrams are typical values. (not assurance value)

- (Notice) • In the absence of confirmation by device specification sheets, SHARP takes no responsibility for any defects that may occur in equipment using any SHARP devices shown in catalogs, data books, etc. Contact SHARP in order to obtain the latest device specification sheets before using any SHARP device.  
 (Internet) • Data for sharp's optoelectronic/power device is provided for internet.(Address <http://www.sharp.co.jp/ecg/>)

# LED Lamp Characteristics Diagrams

## PR series

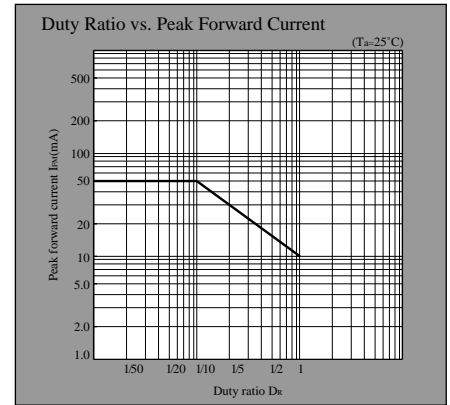
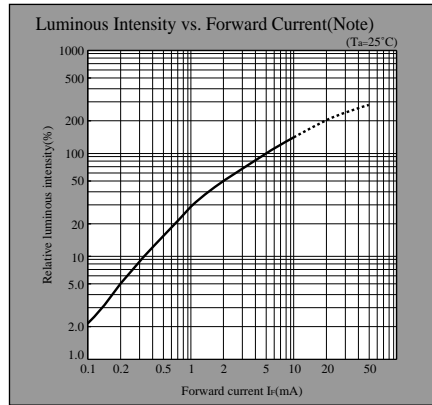
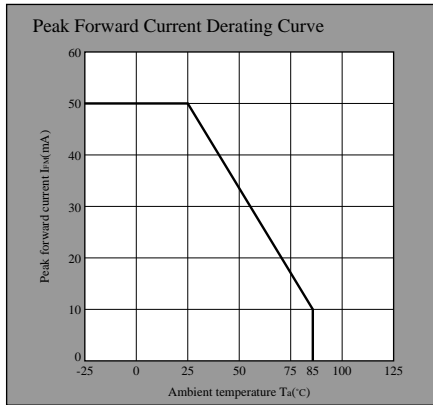
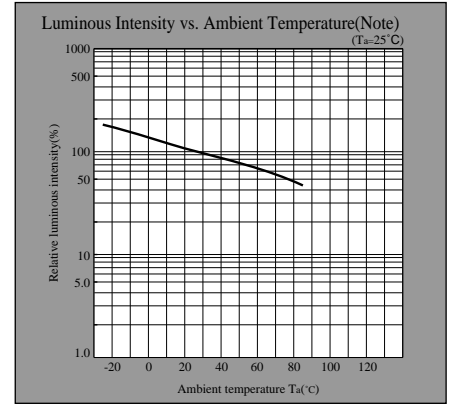
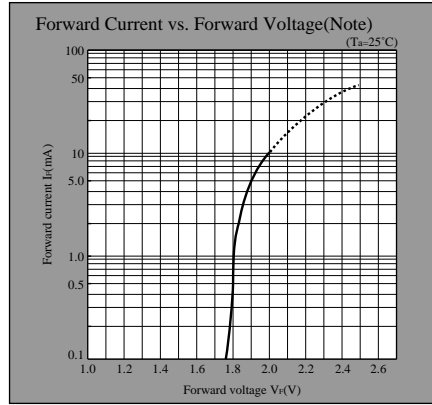
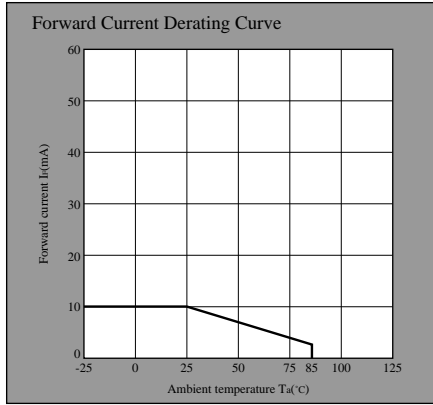

## HD series

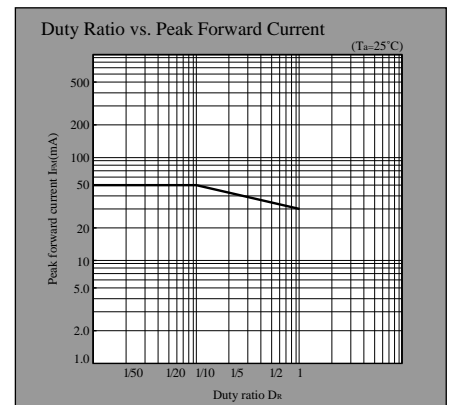
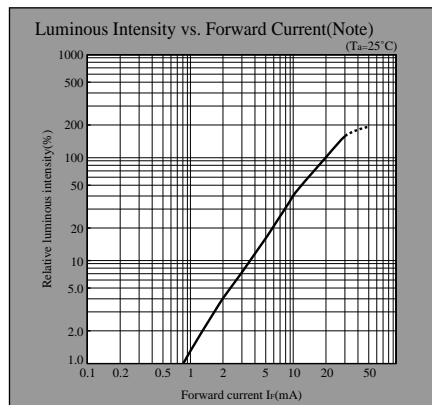
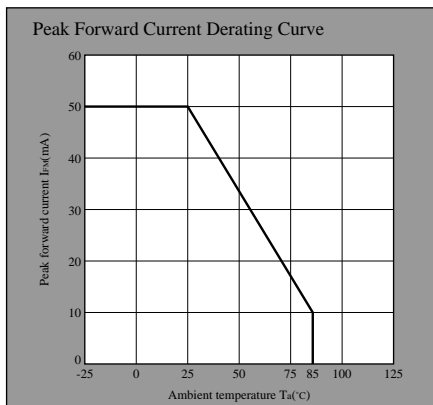
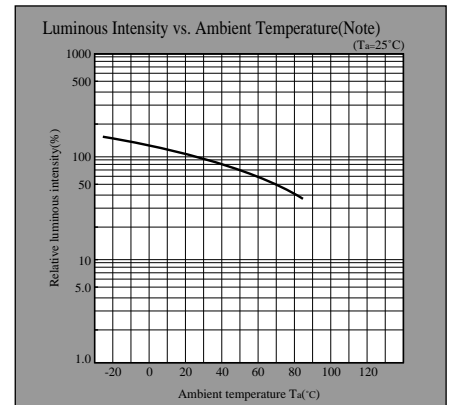
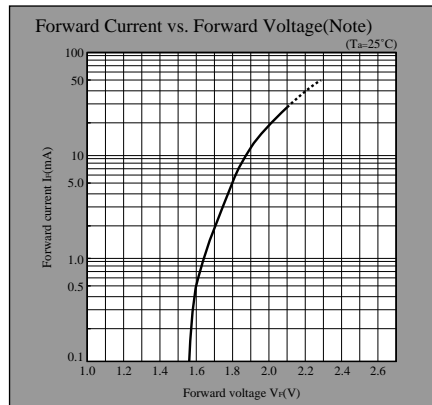
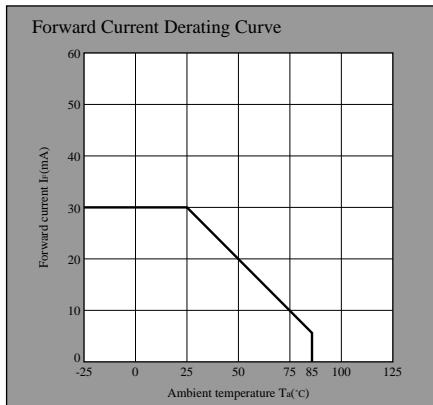

Note) Characteristics shown in diagrams are typical values. (not assurance value)

- (Notice) • In the absence of confirmation by device specification sheets, SHARP takes no responsibility for any defects that may occur in equipment using any SHARP devices shown in catalogs, data books, etc. Contact SHARP in order to obtain the latest device specification sheets before using any SHARP device.  
 (Internet) • Data for sharp's optoelectronic/power device is provided for internet.(Address <http://www.sharp.co.jp/ecg/>)

# LED Lamp Characteristics Diagrams

## HS series

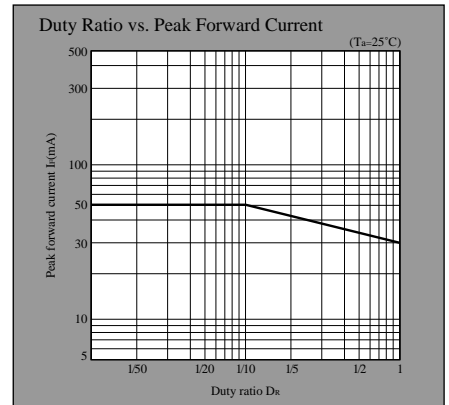
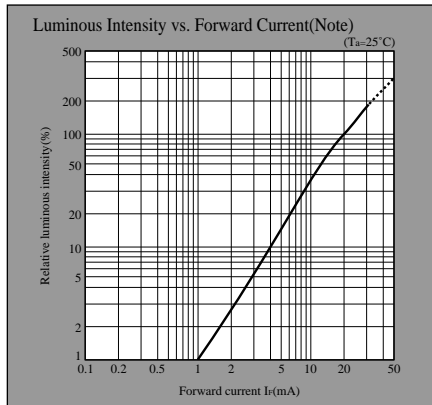
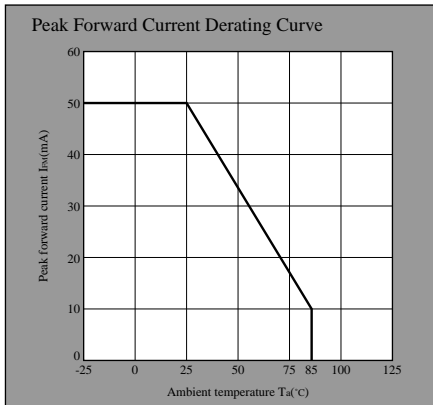
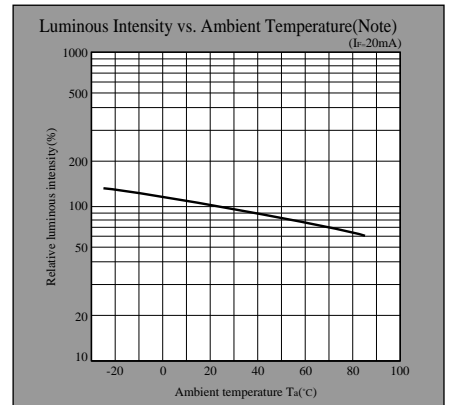
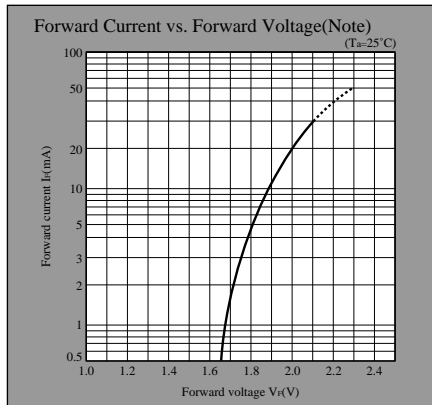
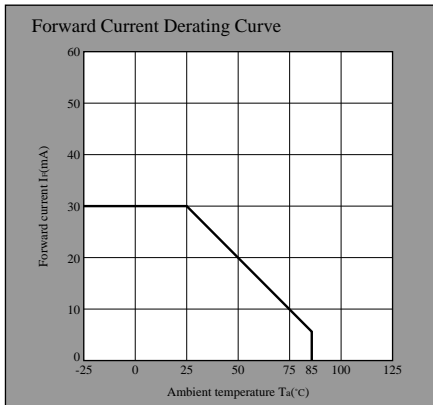

## HY series

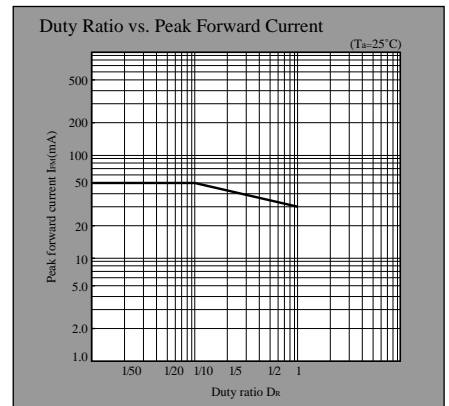
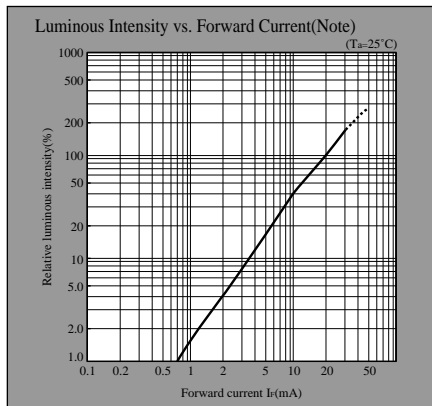
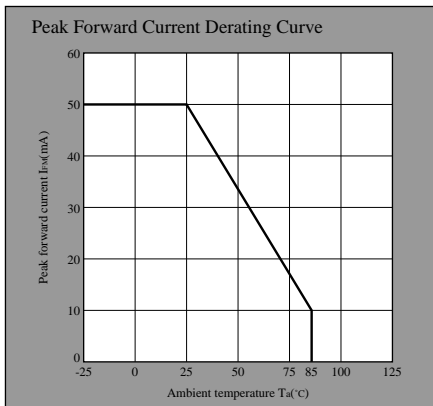
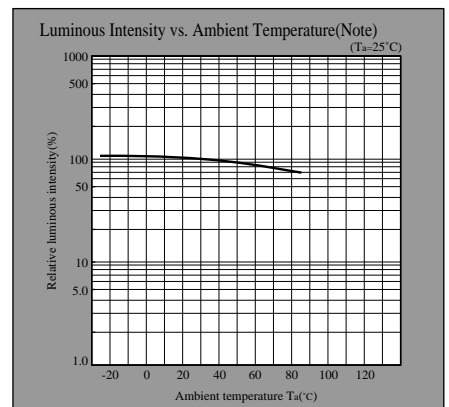
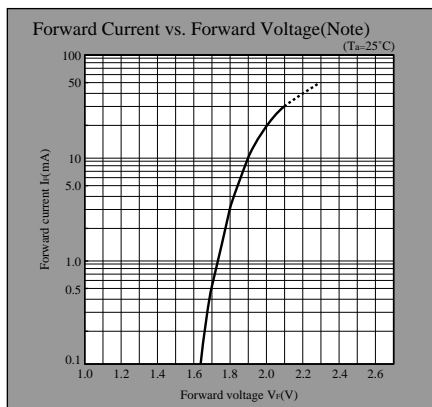
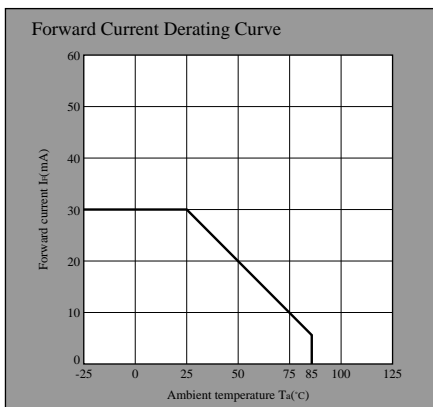

Note) Characteristics shown in diagrams are typical values. (not assurance value)

- (Notice) • In the absence of confirmation by device specification sheets, SHARP takes no responsibility for any defects that may occur in equipment using any SHARP devices shown in catalogs, data books, etc. Contact SHARP in order to obtain the latest device specification sheets before using any SHARP device.  
 (Internet) • Data for sharp's optoelectronic/power device is provided for internet. (Address <http://www.sharp.co.jp/ecg/>)

# LED Lamp Characteristics Diagrams

## EG series

Forward Current Derating Curve

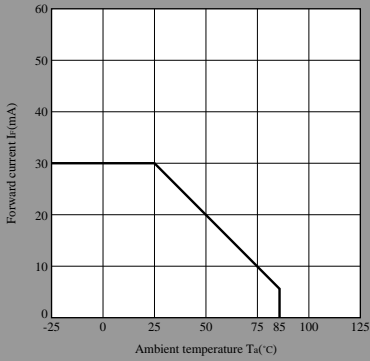

Forward Current vs. Forward Voltage(Note)

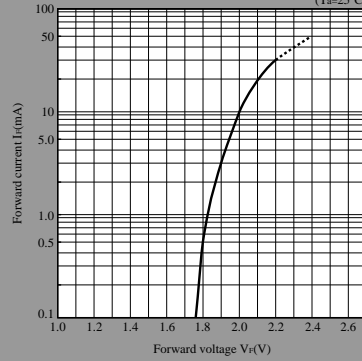

Luminous Intensity vs. Ambient Temperature(Note)

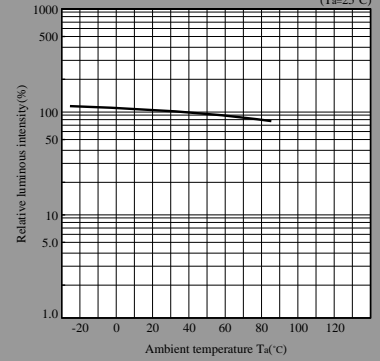

Peak Forward Current Derating Curve

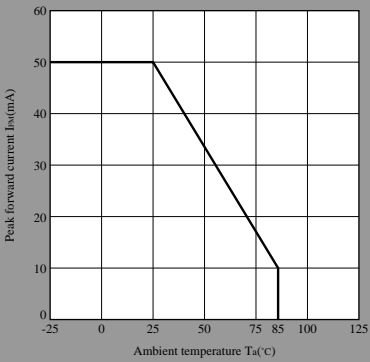

Luminous Intensity vs. Forward Current(Note)

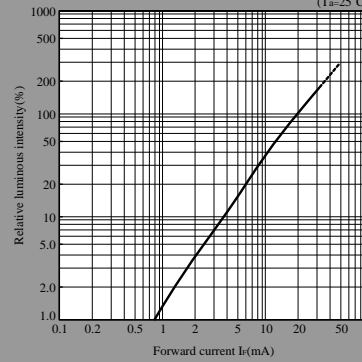

Duty Ratio vs. Peak Forward Current

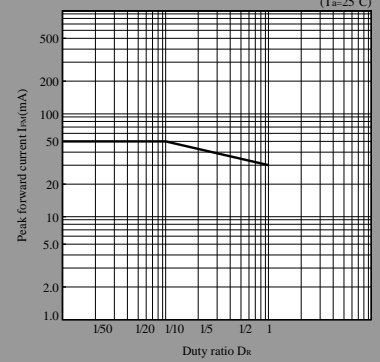

## KG series

Forward Current Derating Curve

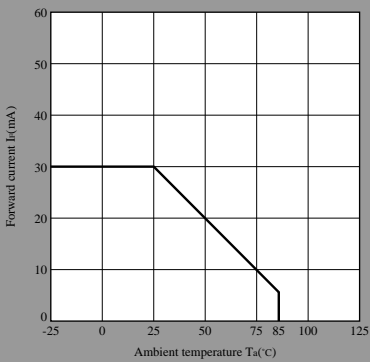

Forward Current vs. Forward Voltage(Note)

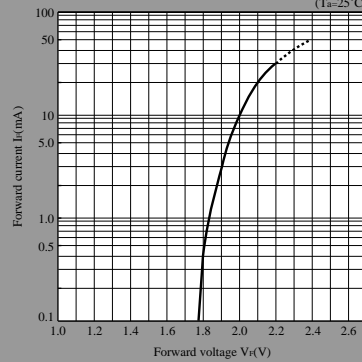

Luminous Intensity vs. Ambient Temperature(Note)

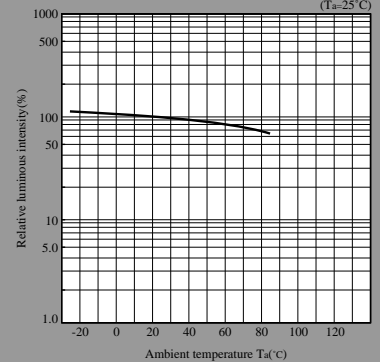

Peak Forward Current Derating Curve

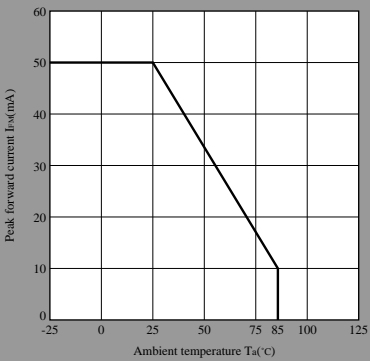

Luminous Intensity vs. Forward Current(Note)

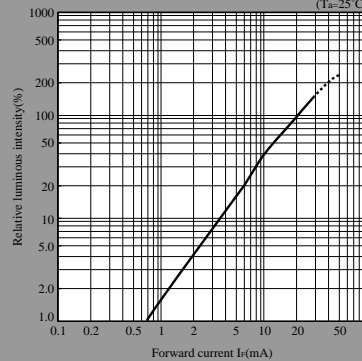

Duty Ratio vs. Peak Forward Current

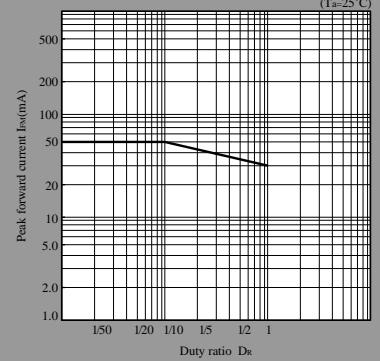

Note) Characteristics shown in diagrams are typical values. (not assurance value)

- (Notice) • In the absence of confirmation by device specification sheets, SHARP takes no responsibility for any defects that may occur in equipment using any SHARP devices shown in catalogs, data books, etc. Contact SHARP in order to obtain the latest device specification sheets before using any SHARP device.  
 (Internet) • Data for sharp's optoelectronic/power device is provided for internet.(Address <http://www.sharp.co.jp/ecg/>)